

Montageanleitung

nymea:energy

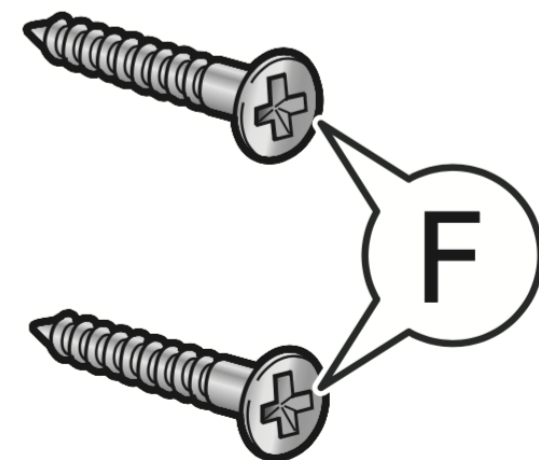

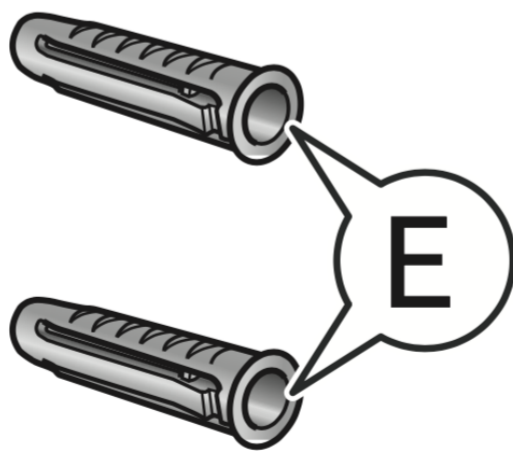

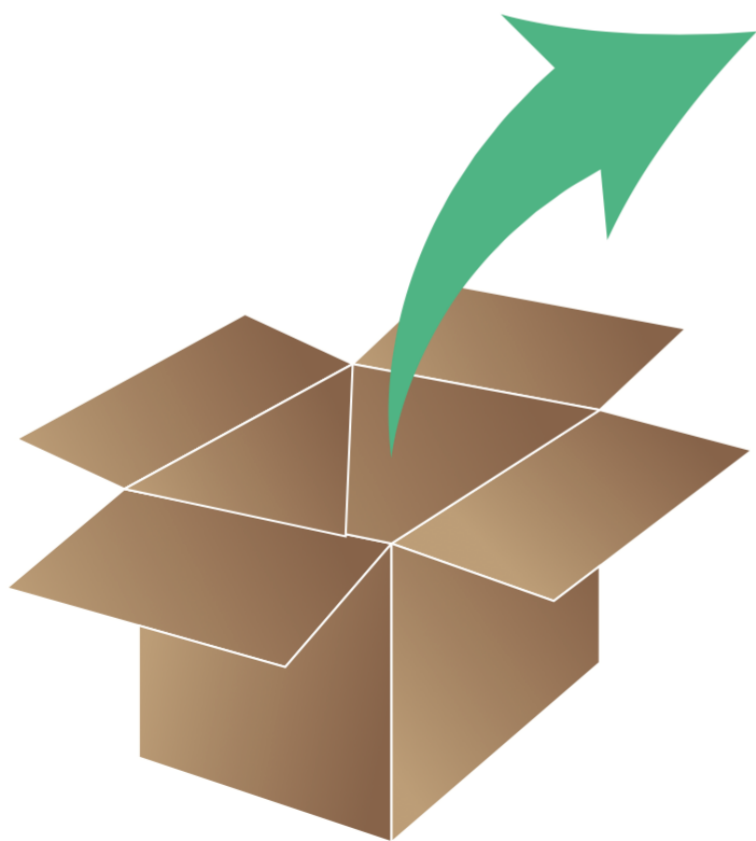
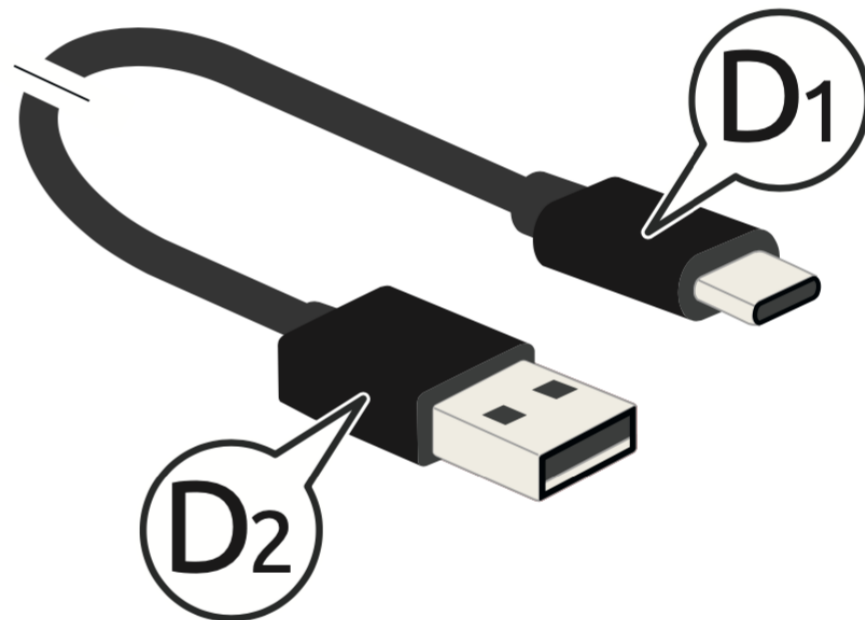
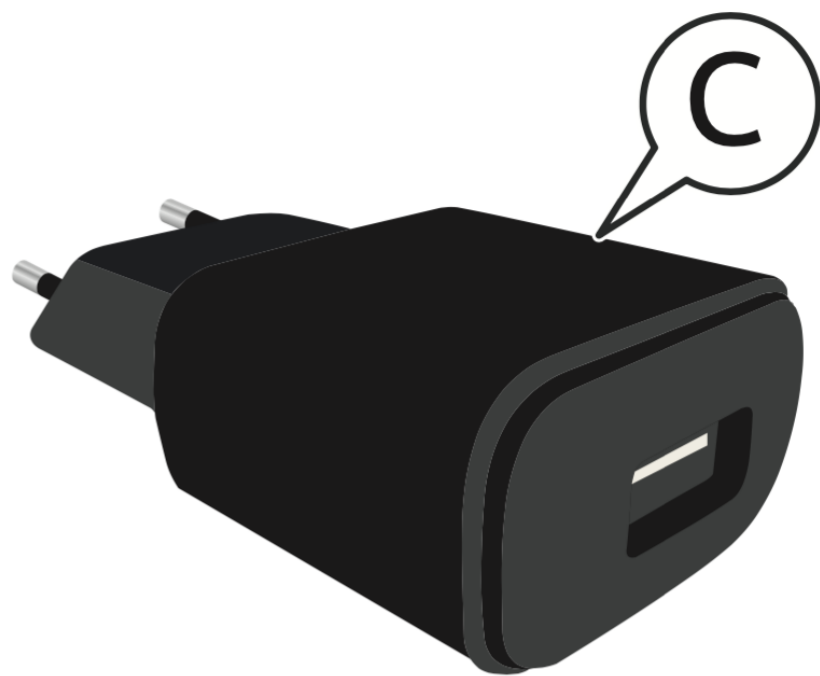
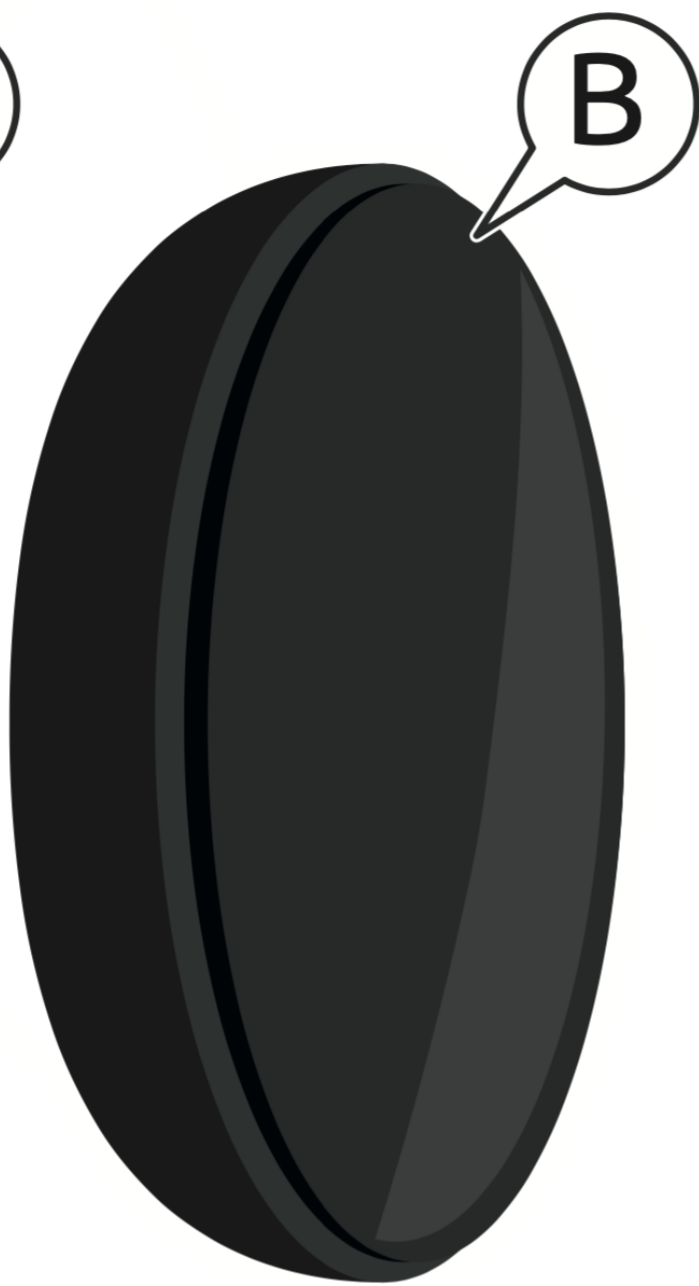
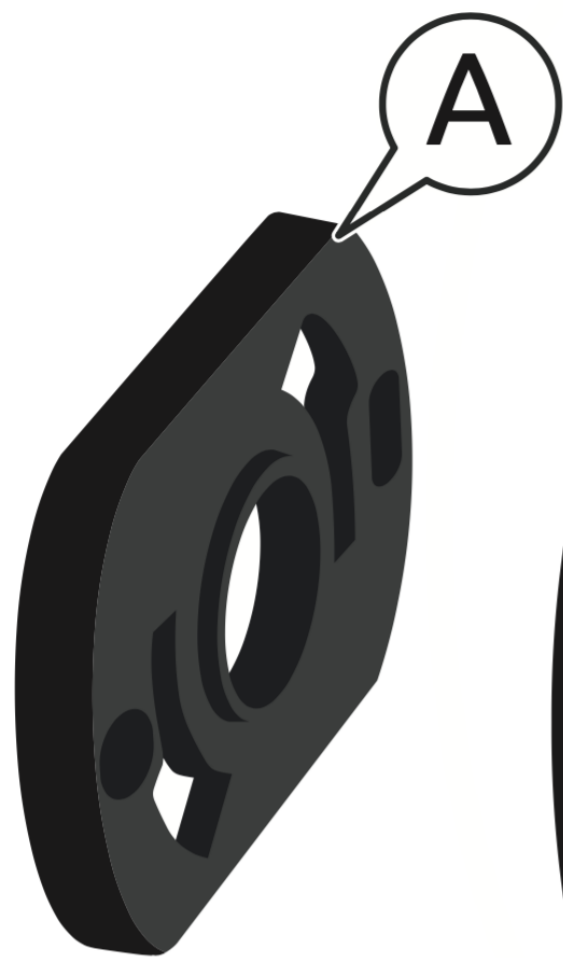
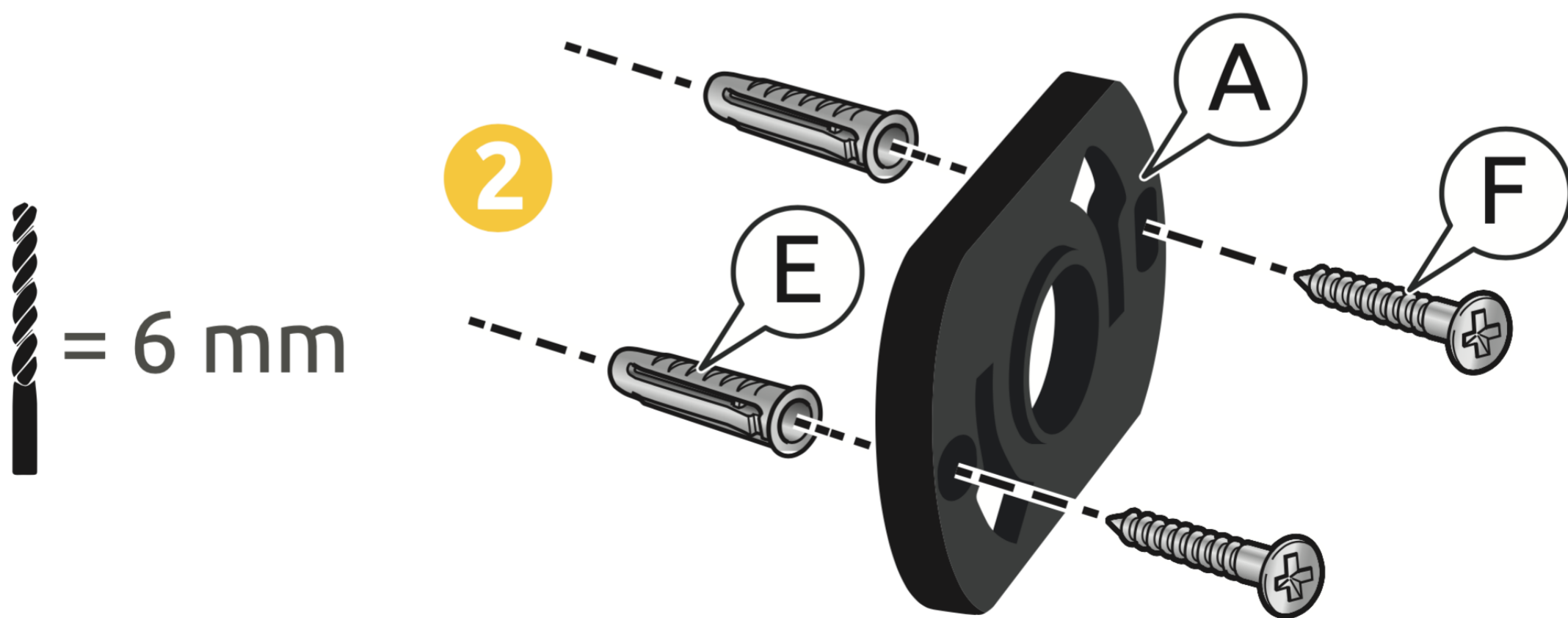
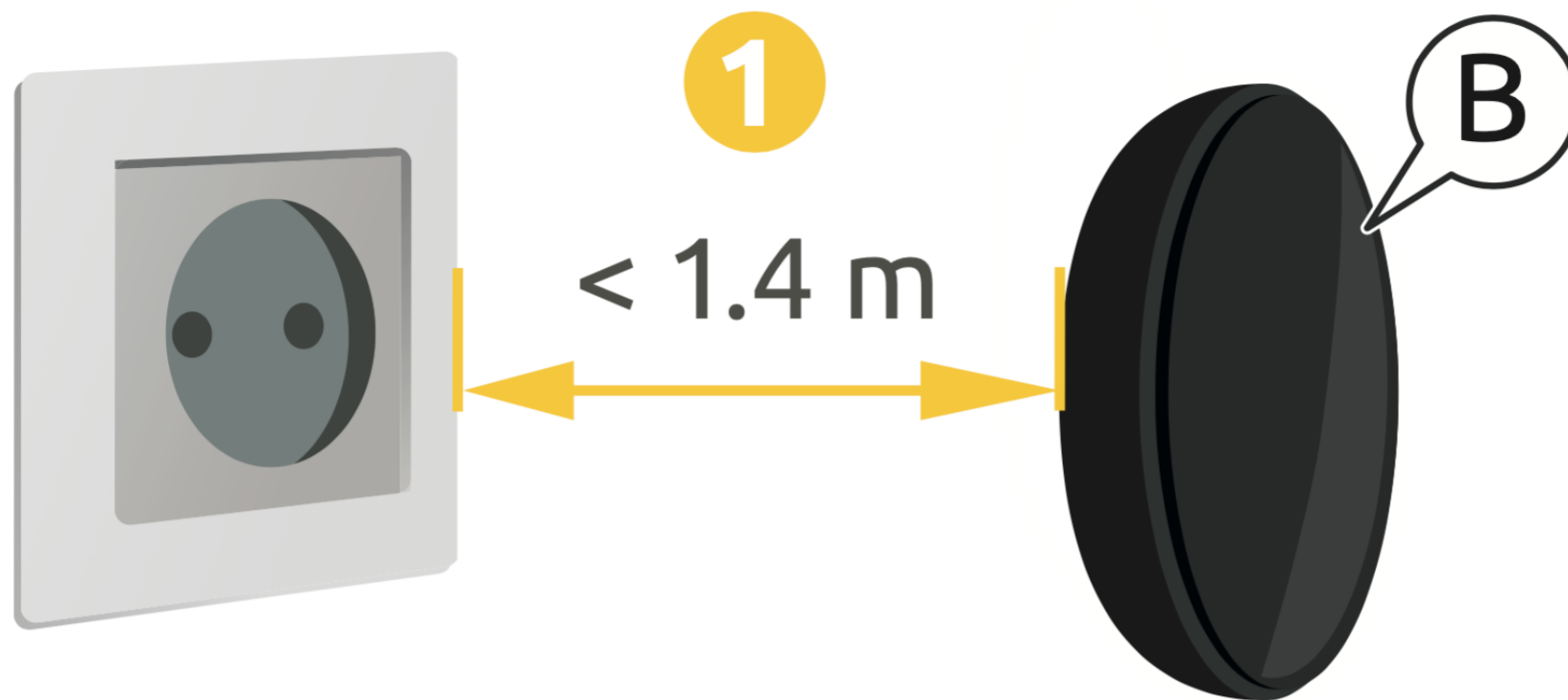

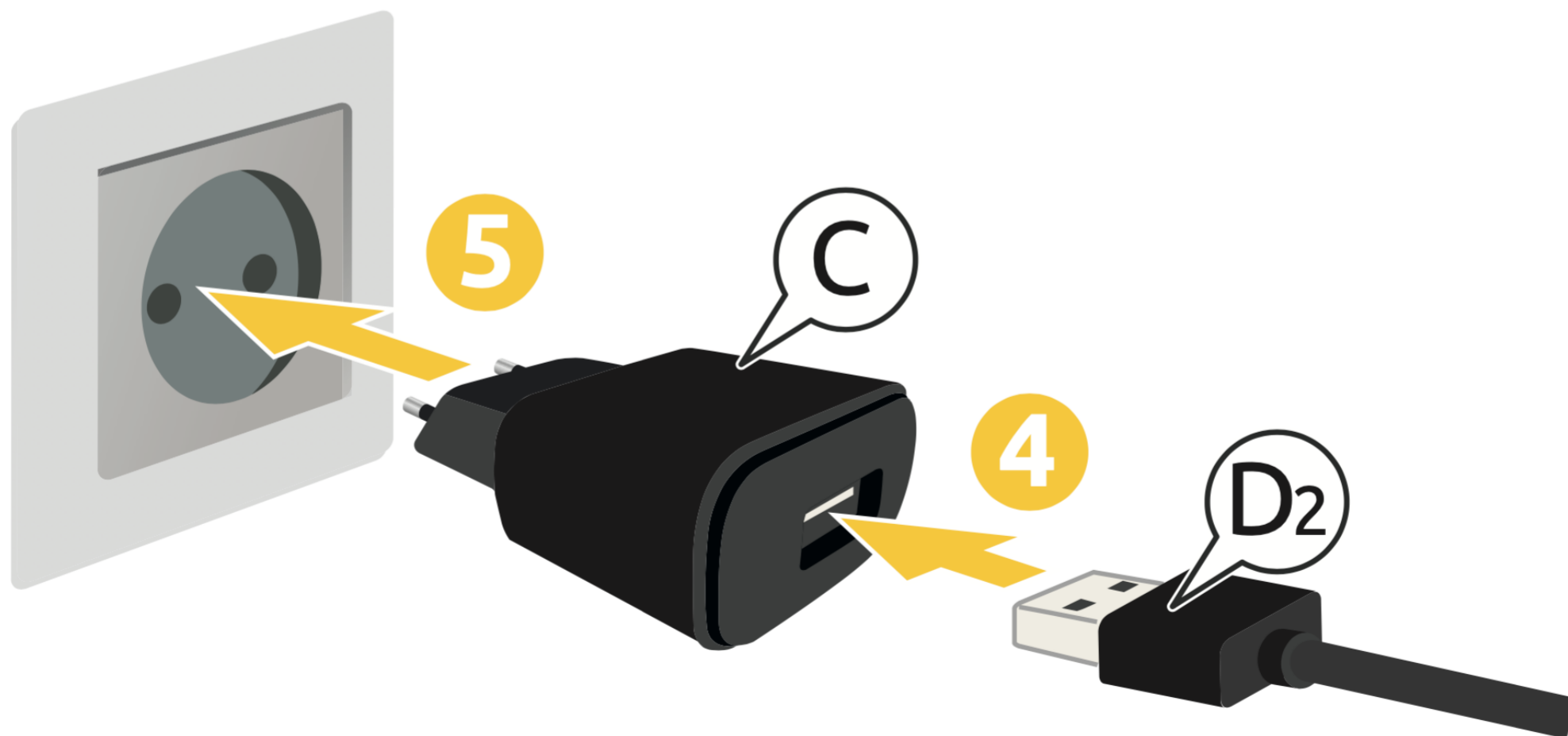
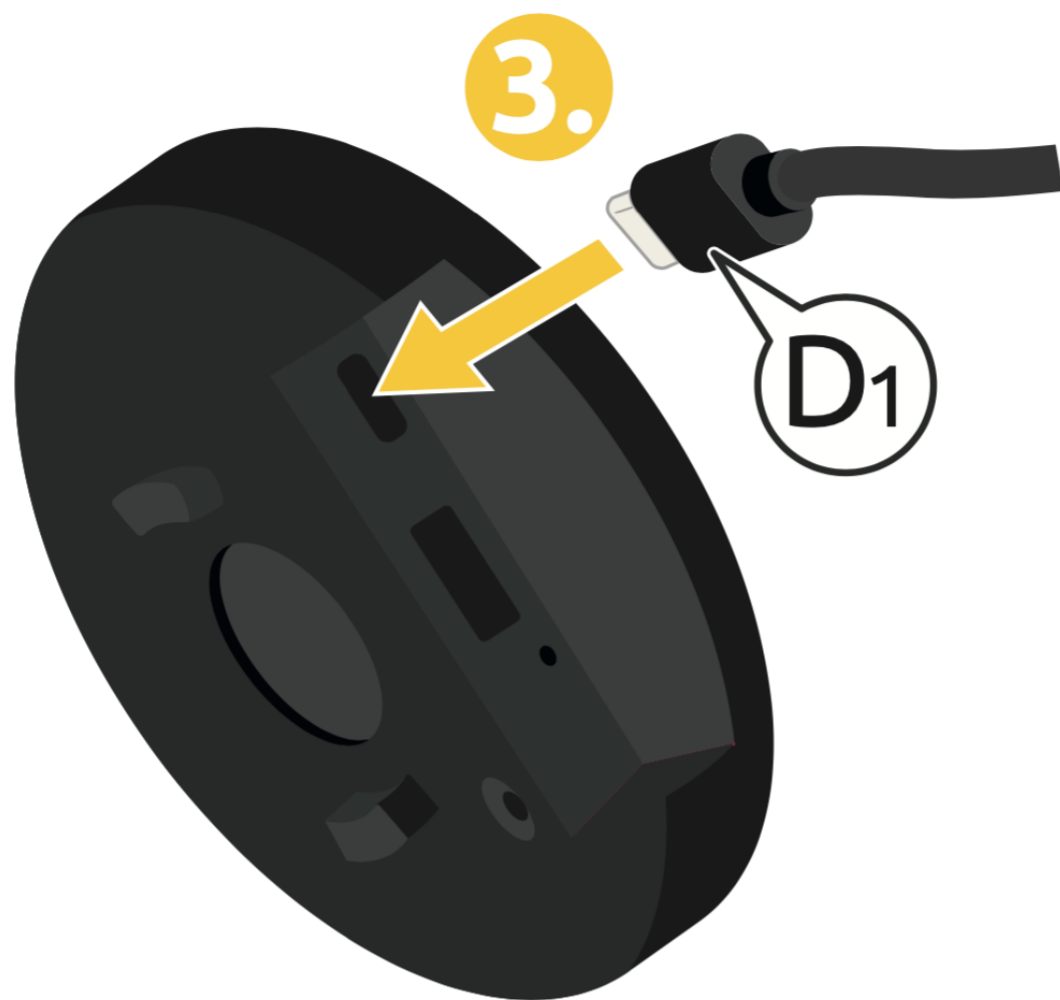

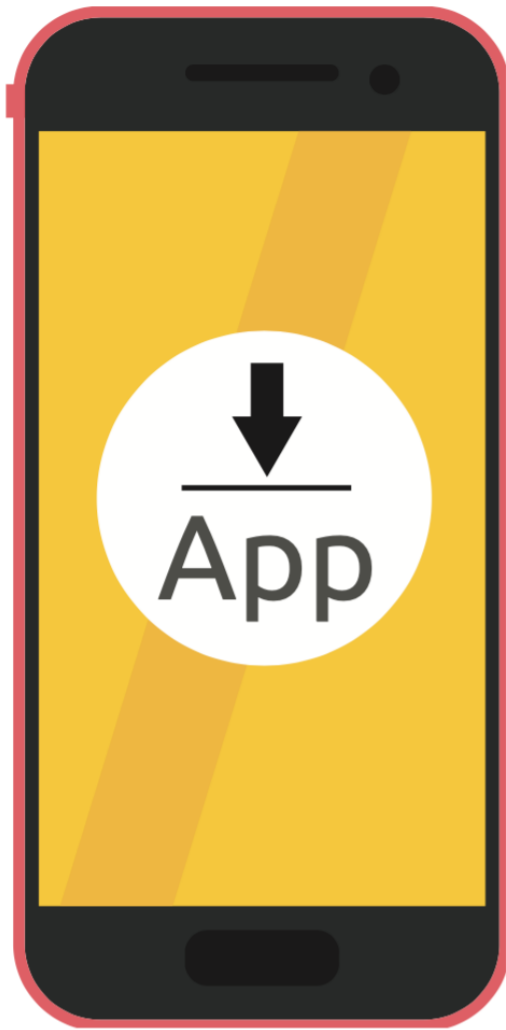

6



7

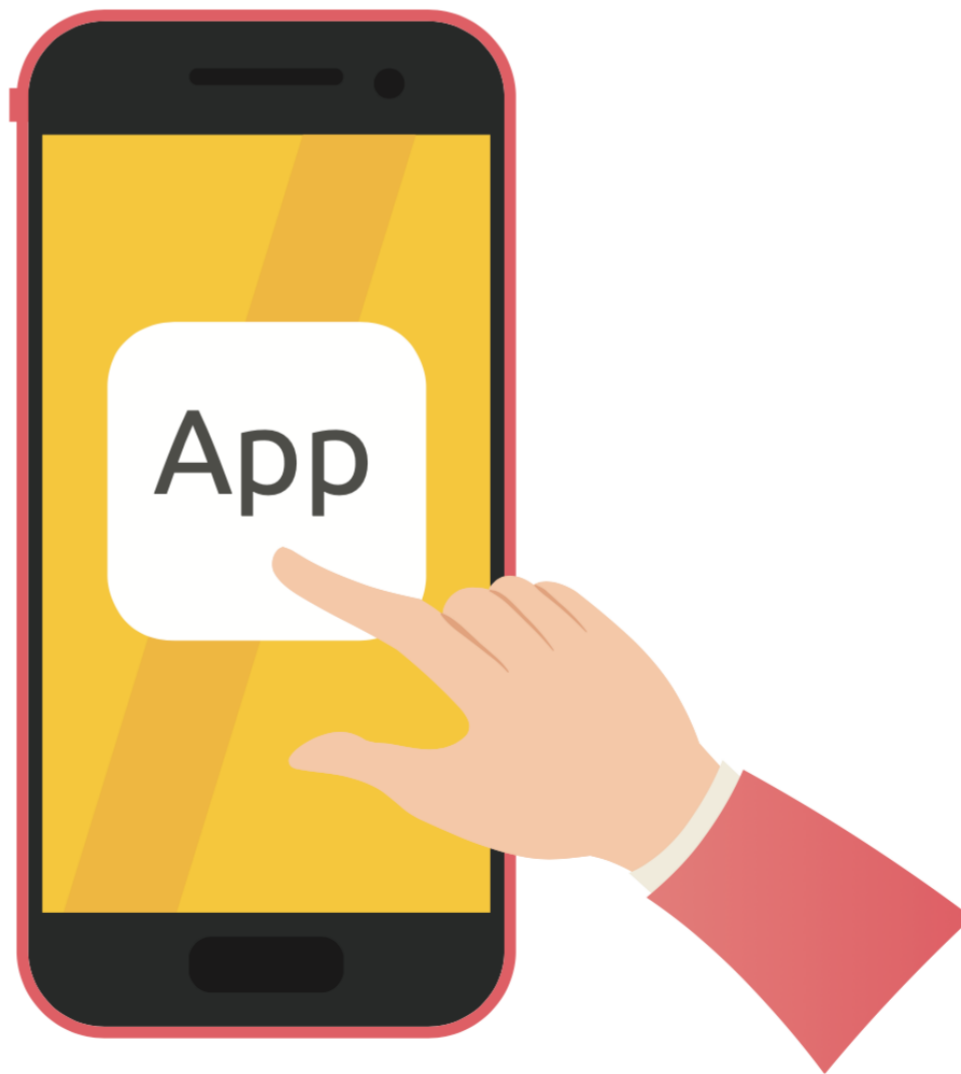

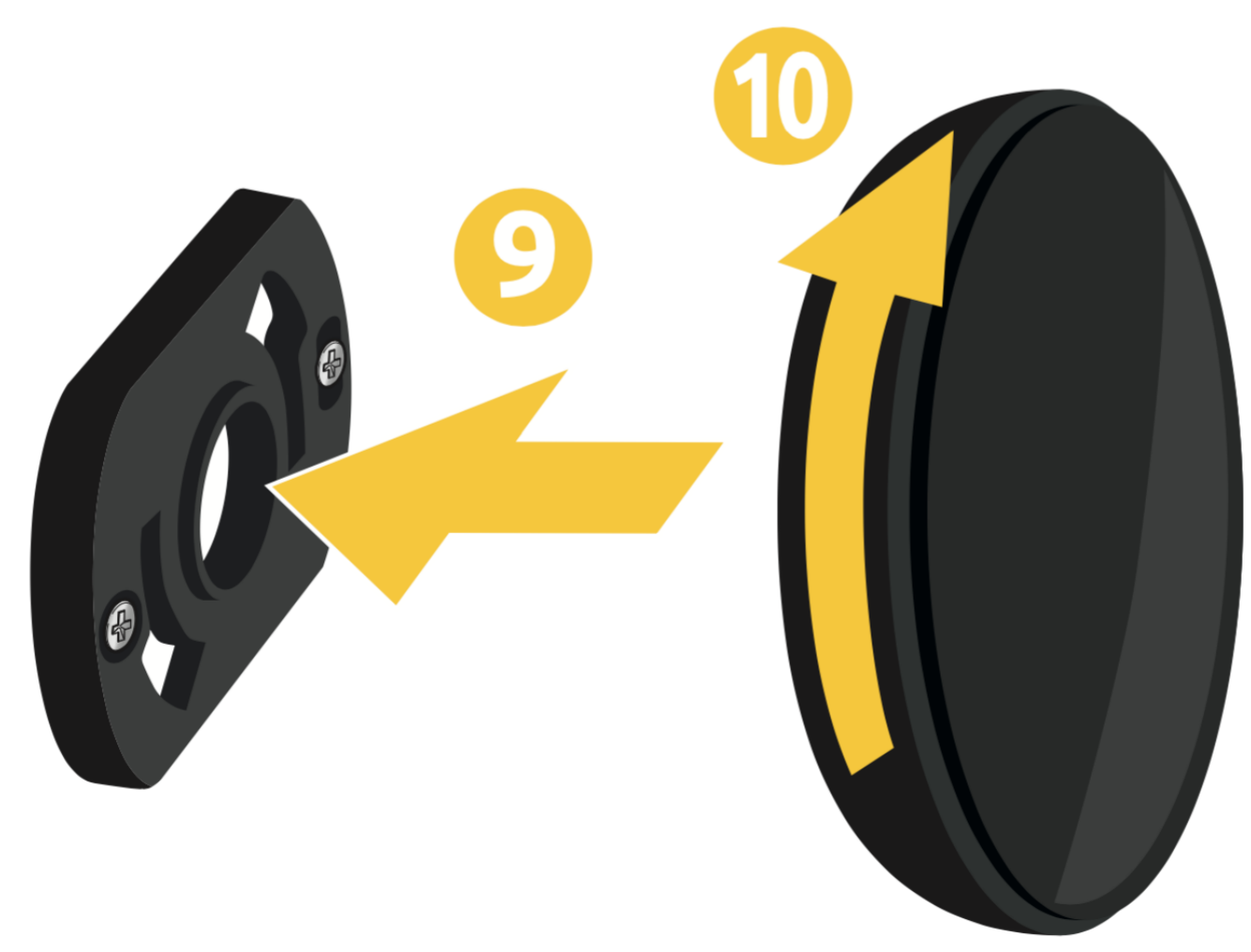
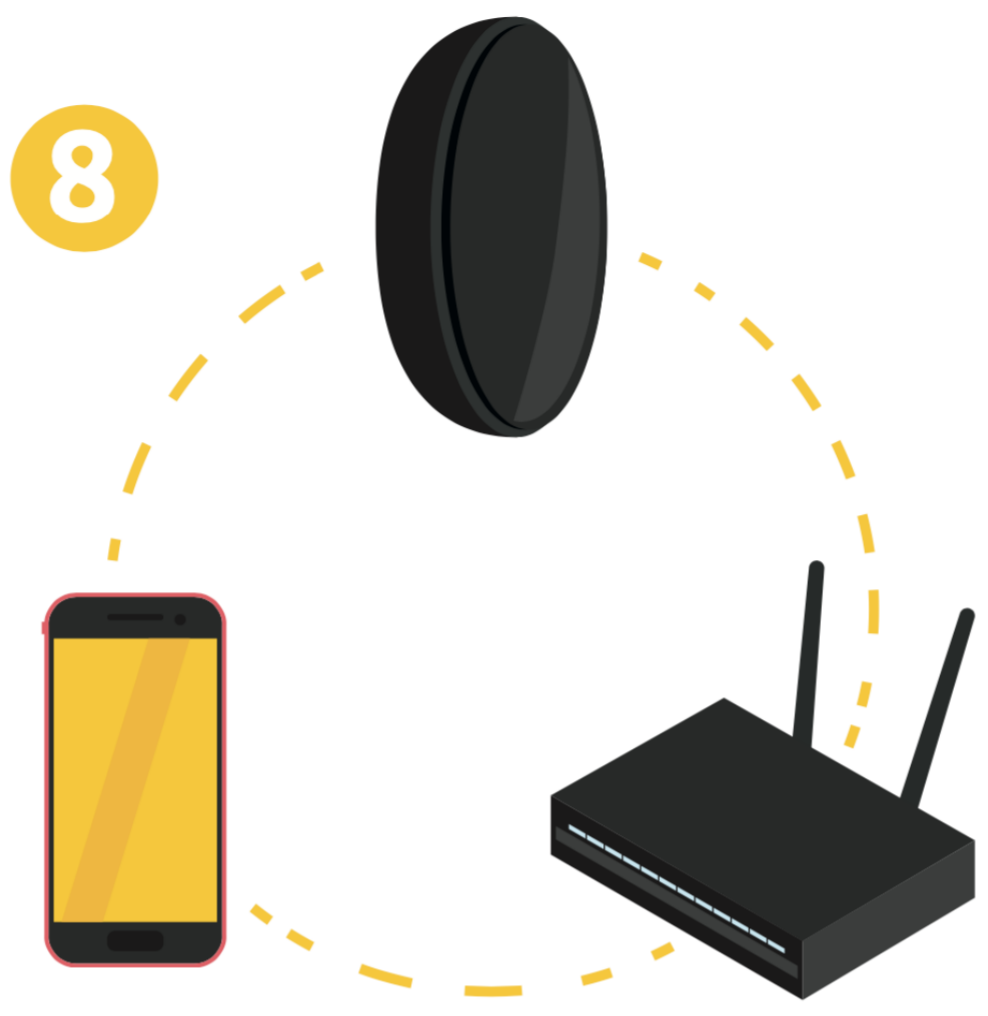

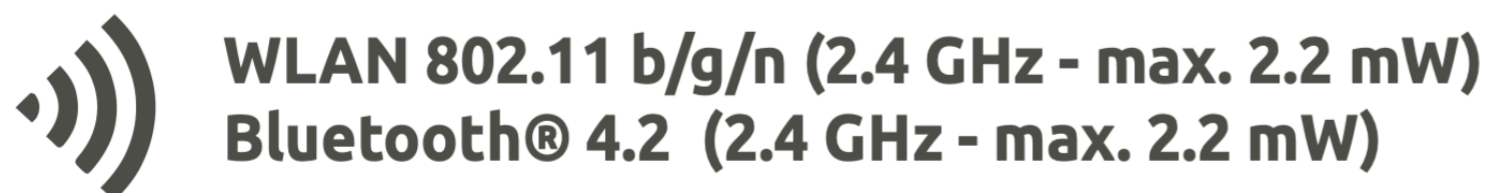
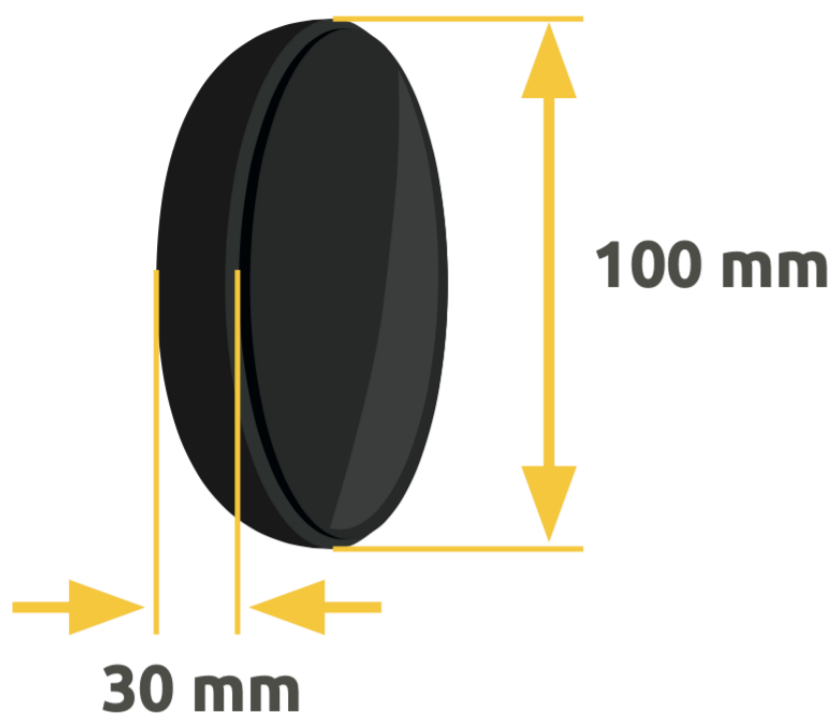

Hergestellt von

Marantec Antriebs- und Steuerungstechnik GmbH & Co. KG

Remser Brook 11

33428 Marienfeld

Germany

Google Play and the Google Play logo are trademarks of Google Inc.

Apple and the Apple logo are trademarks of Apple Inc., registered in the U.S. and other countries. App Store is a service mark of Apple Inc., registered in the U.S. and other countries.

The Bluetooth® word mark and logos are registered trademarks owned by the Bluetooth SIG, Inc. and any use of such marks by Marantec Antriebs- und Steuerungstechnik GmbH & Co. KG is under license. Other trademarks and trade names are those of their respective owners.

Hiermit erklärt Marantec Antriebs- und Steuerungstechnik GmbH & Co. KG, dass der Funkanlagentyp nymea:energy Gateway / maveo box der Richtlinie 2014/53/EU entspricht. Der vollständige Text der EU-Konformitätserklärung ist unter der folgenden Internetadresse verfügbar:
www.smartwithmaveo.com